

JBL

PROFESSIONAL

VT4889 Three-Way High Directivity Line Array Element

VERTec™ Series

Application:

The VT4889 Three-Way Line Array Element is designed to deliver high-quality reinforcement of music and speech in a variety of applications including concert audio and corporate A/V presentations of all types.

Key Features:

- ▶ Advanced technology components: Neodymium Differential Drive®, neodymium magnet, dual voice coil, Direct Cooled™ cone transducers for low weight and high output
- ▶ Industry's smallest, lightest, most powerful 1.5" exit, 3" diaphragm high-frequency compression driver
- ▶ WaveFormer™ units couple to create precision HF vertical slot aperture
- ▶ Radiation Boundary Integrator® (R.B.I.): Patent-pending technology integrates output of individual bandpass elements
- ▶ Advanced construction techniques and hybrid materials provide exceptionally rigid, lightweight enclosure construction
- ▶ Rugged DuraFlex™ exterior finish; weatherized components
- ▶ Integrated S.A.F.E.™ suspension system: premium heat-treated alloys provide rigid, reliable hanging arrays

The above features come together in a line array system with performance advantages offering benefits for both portable system users and fixed-venue installations. The VT4889 combines time-tested acoustical physics with JBL's innovative transducer research and design in a premium-grade system package. JBL's VERTec (Vertical Technology) builds on proven line array theory as demonstrated in JBL's line array systems in the early 1970's.

The VT4889 is a rugged, lightweight enclosure housing two 15" woofers, four 8" midrange radiators, and three high-frequency compression drivers. These advanced components provide the highest power-to-weight ratio of any speaker system in its class.

Enclosure features foam-backed low-frequency grilles, dense protective foam inserts for midrange apertures, and a fine steel mesh grille to protect high-frequency apertures. All speaker cones are treated with weather-resistant compounds. Rigging frames and hinge bars are made from premium-grade chromemoly alloy steel, with epoxy power coating over zinc-plated surfaces; hinge pins are



cadmium-plated and quick-release pin restraining lanyards are stainless steel to resist corrosion and weather damage.

VERTec arrays are rigid for maximum support strength, yet flexible in design and application. The VT4889's suspension hardware relies on quick-release pins and end-mounted metal frames to couple adjacent VT4889's together. Enclosure ships with available front and rear hinge bar set (VT4889-RIG), available padded soft bag (VT4889-COVER) and protective grille cover/wheelboard (VT4889-DOLLY) to ensure handy transport for rough road conditions.

Specifications:

Line Array Element

Freq. Response (± 3 dB):	45 Hz - 16 kHz
Horizontal Coverage Angle (-6 dB):	90 deg. nominal, 250 Hz - 16 kHz
Vertical Coverage Angle (-6 dB):	Varies with array size and configuration
Maximum Peak Output:	136 dB to 146 dB @ 1m (Frequency/bandpass dependent)
Recommended Signal Processing:	Digital System Controller: dbx 480. BSS 366, XTA 226 also supported

Transducer Sections

Low Frequency:	(2) x 2255HPL, 380 mm (15 in.) dia., 76 mm (3 in.) Dual Coil, Neodymium Differential Drive, Direct Cooled
Nominal Impedance (each driver):	8 ohms, independently wired
Input Power Rating:	1200W, AES, system bandpass (600W per driver)
Bandpass Sensitivity:	99 dB, 1w/1m (3.3 ft.)
Mid Frequency:	(4) x 2250H, 203 mm (8 in.) dia., 76 mm (3 in.) dual coil, Neodymium Differential Drive®, Direct Cooled™
Nominal Impedance (bandpass):	8 ohms, wired series parallel
Input Power Rating:	1200W, AES, system bandpass (300W per driver)
Bandpass Sensitivity:	102 dB, 1w/1m (3.3 ft.) (system bandpass)
High Frequency:	(3) x 2435H, 76 mm (3 in.) dia., beryllium diaphragm voice coil, 38 mm (1.5 in.) throat diameter
Nominal Impedance (bandpass):	16 ohms, wired in series
Input Power Rating:	225W, AES, system bandpass (75W per driver)
Bandpass Sensitivity:	116 dB, 1w/1m (3.3 ft.) (system bandpass)

Enclosure / Suspension Hardware

Box Construction:	Wedge frustum, 5 degree side angle composite enclosure, DuraFlex finish, 8 handles
Suspension System:	S.A.F.E. hardware, integral hinge bars nest in rigging frames on box ends. Quick release pins with restraining lanyards
Grille:	Separate LF and HF, black, perforated steel. LF grilles foam-backed
Input Connectors:	NL8, 2 each
Dimensions (H x W x D):	489 mm x 1213 mm x 546 mm (19.25" x 47.75" x 21")
Net Weight:	72 kg (159 lbs.) incl. rigging frames & hinge bars
Shipping Weight:	91 kg (200 lbs.) incl. Dolly, Cover, packaging

▶ VT4889 Three-Way High Directivity Line Array Element

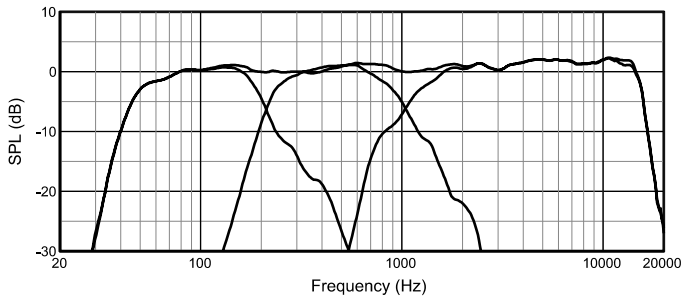

**Normalized Frequency Response
(Individual bandpasses with composite overlay)**

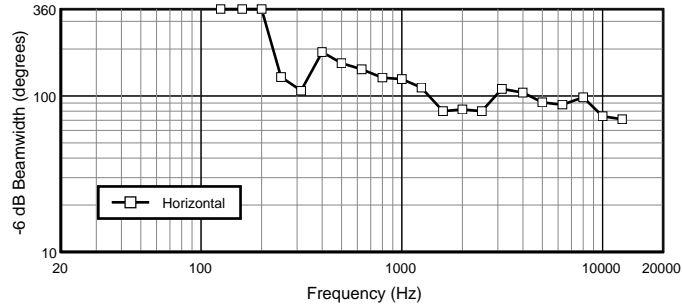

Horizontal Beamwidth, Single Element and Typical Array

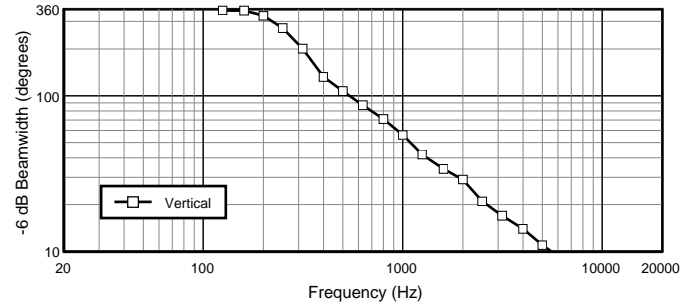

Vertical Beamwidth, Single Line Array Element

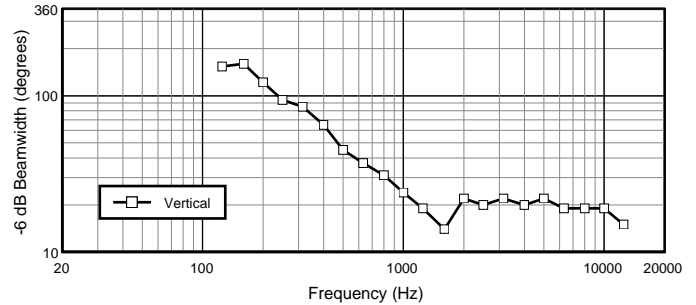

**Vertical Beamwidth, Two Element Array
(10° splay between cabinets)**

VT4889 Acoustical Measurements

The acoustical performance of line array elements must be considered within the context of a multi-box vertical array, in which format they are designed to be used. The frequency response measurement shows individual bandpass responses with composite response overlay. The Vertical Beamwidth results range from a single box up to an 8-box array with 10° splay angles between adjacent array elements.

All measurements provided herewith are derived from data gathered with a calibrated measurement microphone centered on-axis of the box or array, with polar data points taken symmetrically around the measurement axis.

All polars were taken as groundplane measurements at a distance of 20 meters, with data gathered on 5-degree intervals from 0-355° using the MLSSA measurement system.

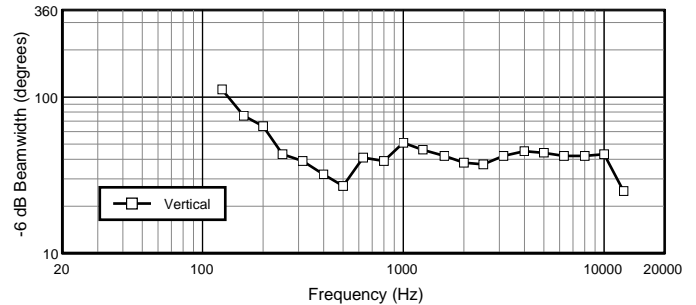

**Vertical Beamwidth, Four Element Array
(10° splay between cabinets)**

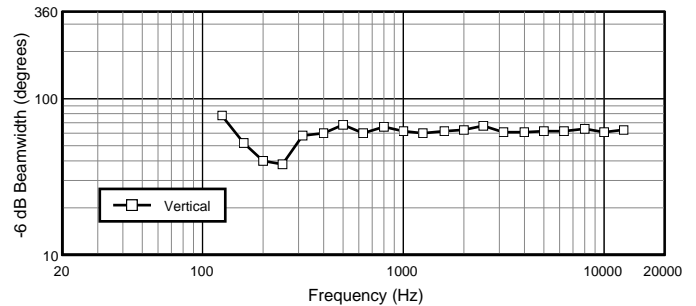

**Vertical Beamwidth, Six Element Array
(10° splay between cabinets)**

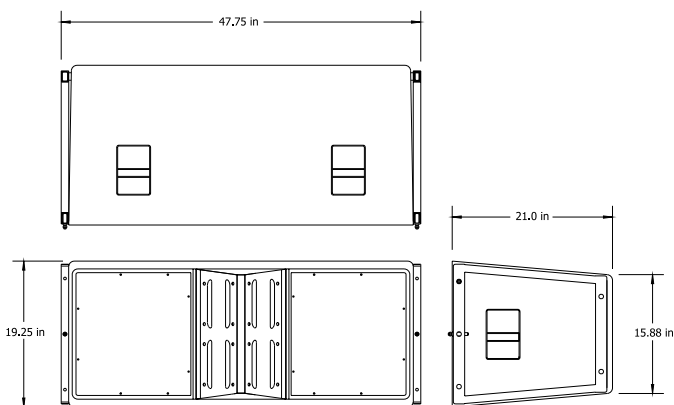

Metric Dimensions: 546mm (H) x 1213mm (W) x 489mm (D)

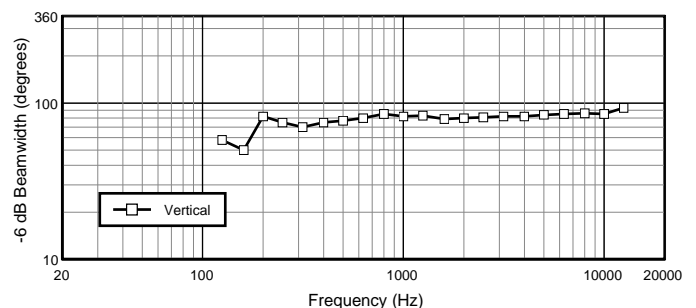

**Vertical Beamwidth, Eight Element Array
(10° splay between cabinets)**

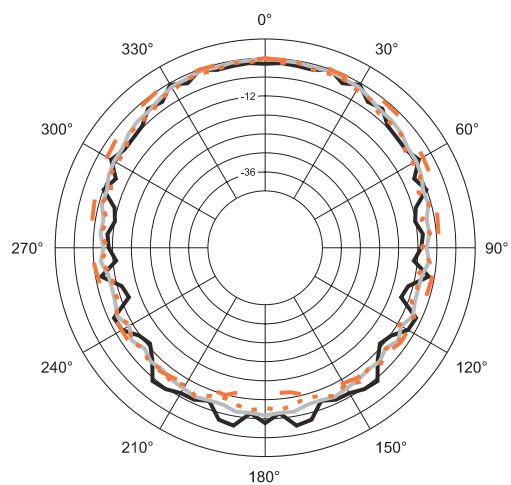

- 200Hz
- 250Hz
- ⋯ 315Hz
- 400Hz

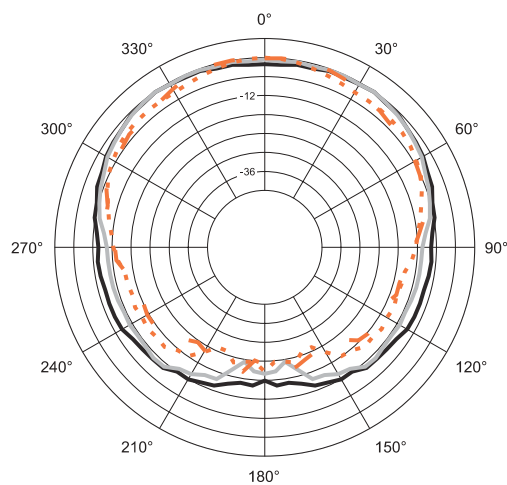

- 500Hz
- 630Hz
- ⋯ 800Hz
- 1kHz

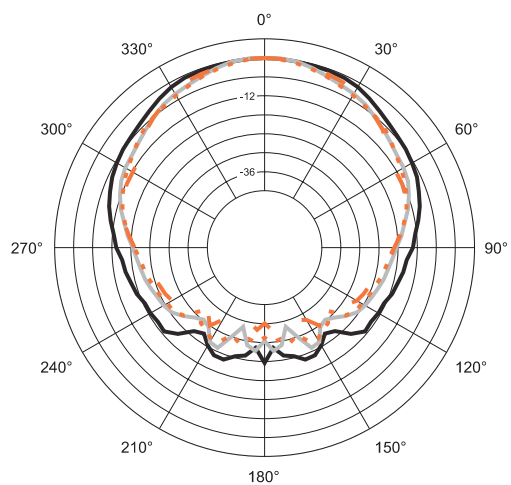

- 1.25kHz
- 1.6kHz
- ⋯ 2kHz
- 2.5kHz

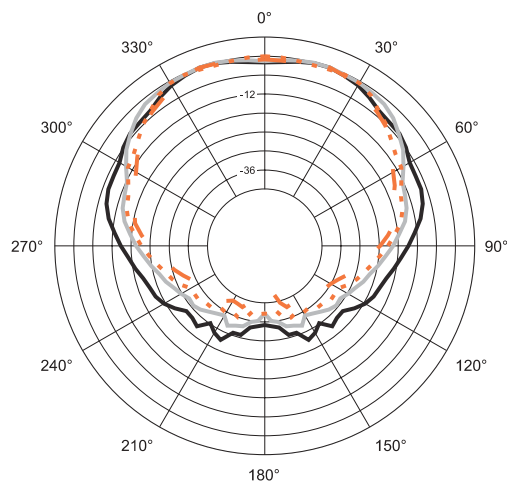

- 3.15kHz
- 4kHz
- ⋯ 5kHz
- 6.3kHz

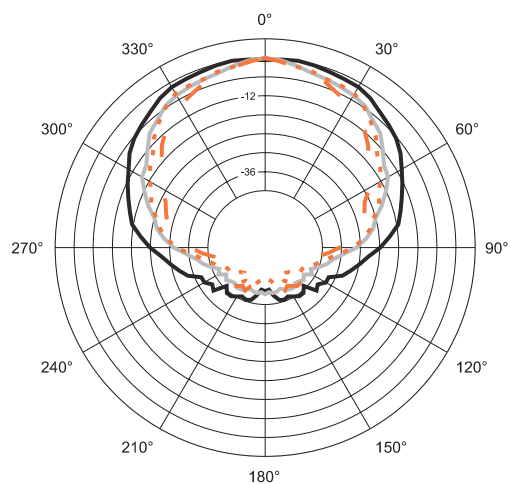

- 8kHz
- 10kHz
- ⋯ 12.5kHz
- 16kHz

Horizontal 1/3 Octave Polars (Single VT4889 Array Element)

Data taken as groundplane measurements at a distance of 20 meters, gathered on 5-degree intervals from 0-355° using the MLSSA measurement system.

▶ VT4889 Three-Way High Directivity Line Array Element

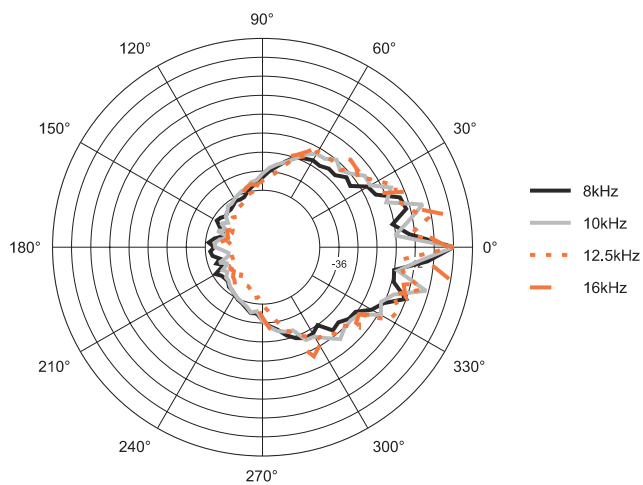
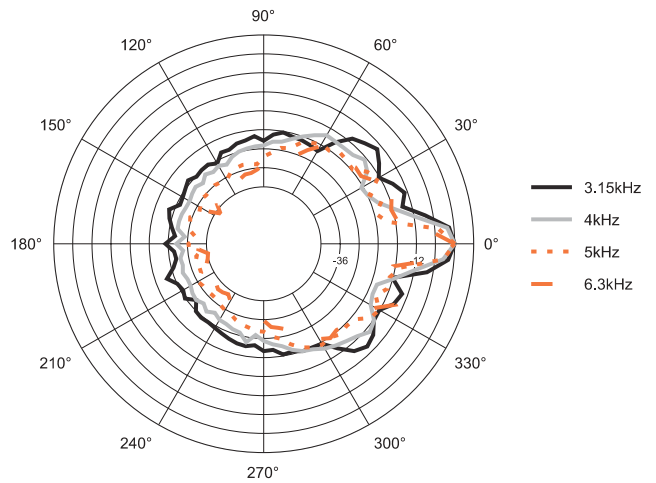
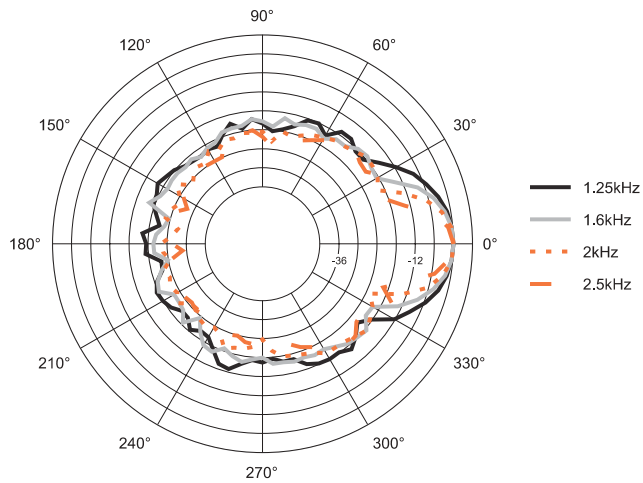
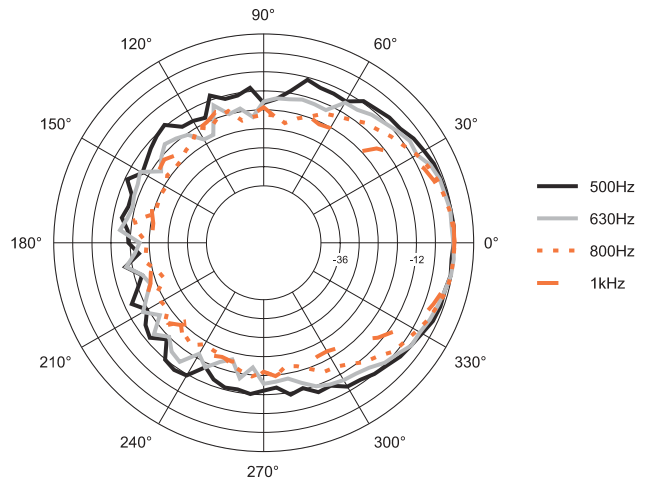
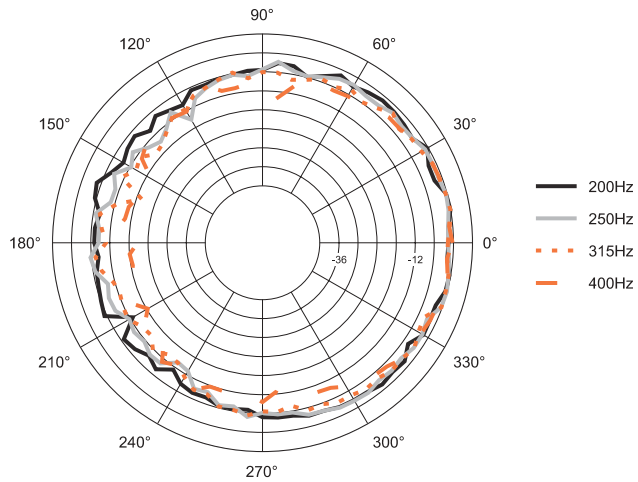

Vertical 1/3 Octave Polars (Single VT4889 Array Element)

Data taken as groundplane measurements at a distance of 20 meters, gathered on 5-degree intervals from 0-355° using the MLSSA measurement system.

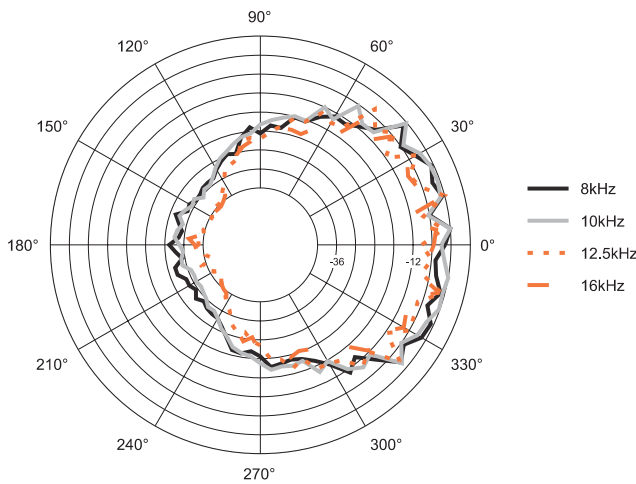
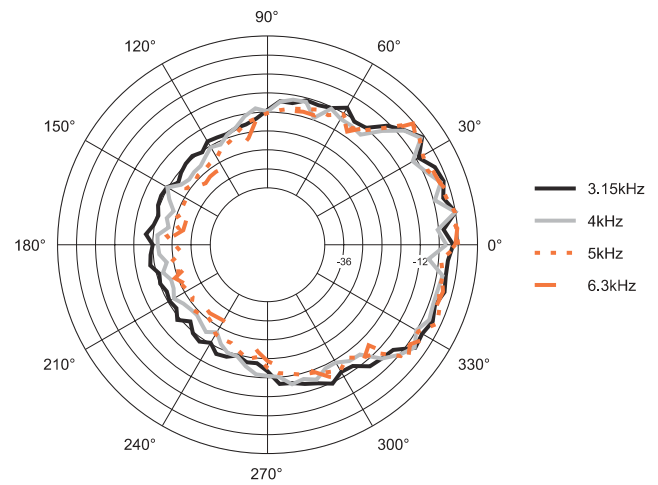
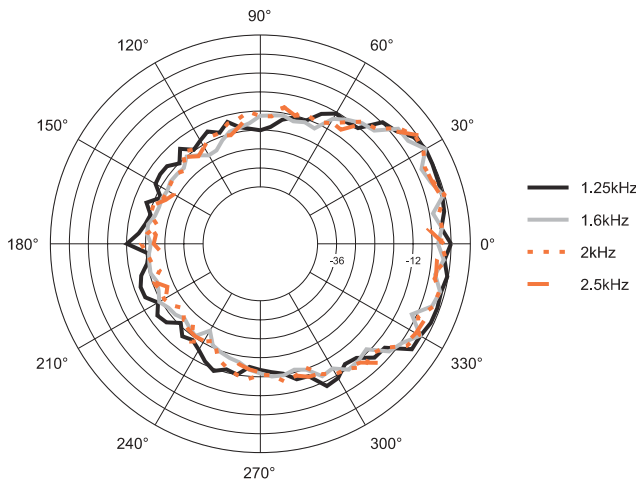
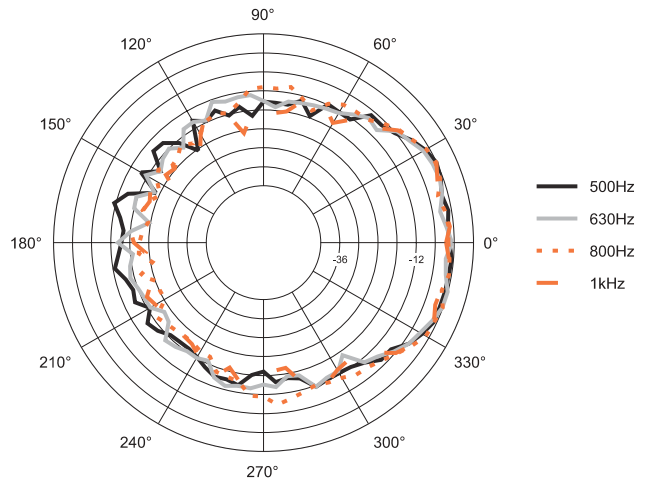
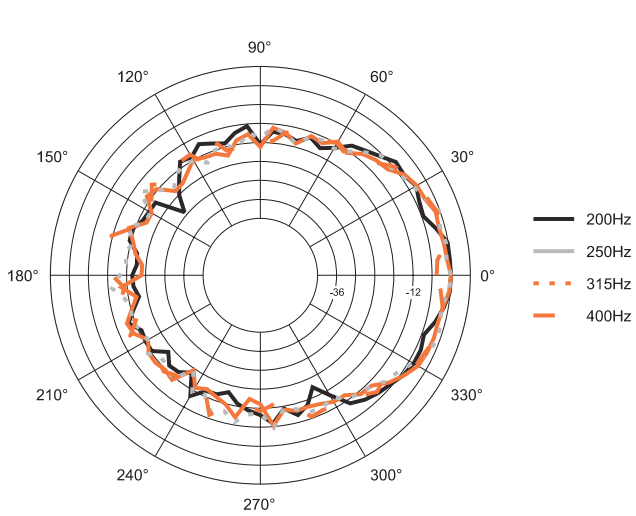

Vertical 1/3 Octave Polars (8-Box Array of VT4889 Enclosures)

Data taken as groundplane measurements at a distance of 20 meters, gathered on 5-degree intervals from 0-355° using the MLSSA measurement system.

▶ VT4889 Three-Way High Directivity Line Array Element

VERTEC System Arrays

The VT4889 is an Articulating Line Array™ designed for use in vertically-oriented, multi-box systems. A nominal horizontal coverage pattern of 90° is maintained, while setting the individual box angles allows the creation of arrays with varying vertical coverage angles. Vertical coverage of an array is a function of the number of boxes used and the splay angles chosen.

Up to 18 (eighteen) of the VT4889 enclosures can be suspended from the available VT4889-AF or VT4889-SF array frames with a 7:1 design factor. Due to the use of JBL's S.A.F.E. suspension hardware system, rigid arrays can be constructed that can be tilted either upwards or downwards at radical angles. Front hinge bars are tightly coupled, while rear hinge bars are used to set angles from zero to ten degrees for adjacent enclosures.

No "gaps" appear on the array's front baffle due to trapezoidal box shape. No "straps" are required on the rear of the array.

VT4889-AF (Array Frame)

This array suspension frame is crafted of 6061 heat-treated aluminum. It includes 11 (eleven) attachment holes for shackles, each fitted with bronze bushings for long life. These holes are set on approx. 4" centers. Each hole has an I.D. (inner diameter) of 1" (25.4 mm). Fitted with SAE Grade 8 bolts, 7075 Grade aluminum receiver blocks and steel quick release pins with stainless steel restraining lanyards. Designed to suspend up to 18 (eighteen) VT4889 enclosures at a 7:1 design factor. Can also be used to groundstack up to 6 (six) enclosures. Weight: 100 lbs. (45 kg).

VT4889-SF (Short Frame)

This array suspension frame is crafted in similar fashion to the VT4889-AF. Designed to suspend up to 18 (eighteen) VT4889 enclosures at a 7:1 design factor. Primarily intended for use with smaller center clusters or satellite-distributed arrays. Optional anchor for use on bottom of large arrays. Can also be used to groundstack up to 4 (four) enclosures. Weight: 52 lbs. (24 kg).

VT4889-RIG

VT4889-RIG comprises a set of four separate hinge bars for the VT4889, two each of the front hinge bar and two each of the longer rear hinge bar. Crafted of premium-grade chromemoly steel alloy with cadmium-plated hinge pins. Extra set is advised for use when groundstacking with the VT4889-AF or VT4889-SF. Weight: 9.5 lbs. (4.3 kg).

VT4889-DOLLY

A rugged protective front grille cover fitted with heavy-duty truck castors. Handle on each side for one-person attachment and removal. Stacking feature to assist in rapid venue setups and takedowns. May be ordered as a separate replacement part. Weight: 25 lbs. (11.3 kg).



JBL Professional
8500 Balboa Boulevard, P. O. Box 2200
Northridge, CA 91329 USA

H A Harman International Company

SSVT4889
CRP 15M 11/01